

# PELONIS

EN

TOWER FAN

PFZ36R0APK

## OWNER'S MANUAL



Warning Notice: Before using this product, please read this manual carefully and keep it for future reference. For additional support, please call customer service at 1-866-646-4332.

The design and specifications are subject to change without prior notice for product improvement. Consult with your dealer or the manufacturer for details.

PFZ36R0APK

[pelonis.com](http://pelonis.com)

## OWNER'S MANUAL

SAFETY PRECAUTIONS .....	1
IMPORTANT INSTRUCTIONS .....	2
PART NAMES .....	5
SPECIFICATIONS .....	5
HOW TO ASSEMBLE .....	6
OPERATING INSTRUCTIONS .....	7
REMOTE CONTROL .....	8
CLEANING MAINTENANCE .....	9
TROUBLESHOOTING .....	9
USER SERVICING INSTRUCTIONS .....	10

### Read This Manual

Inside you'll find many helpful hints on how to use and maintain your appliance properly. Just a little preventive care on your part can save you a great deal of time and money over the life of your appliance. You'll find many answers to common problems in the troubleshooting tips - you should be able to fix most of them quickly before calling service. These instructions may not cover every possible condition of use, so attention to safety details is required when operating and maintaining this product.

## SAFETY PRECAUTIONS

To prevent injury to the user or other people and property damage, the instructions shown here must be followed. Incorrect operation due to ignoring of instructions may cause harm or damage. The different levels of risk are shown by the following indications.

### WARNING

This symbol indicates a hazardous situation which, if not avoided, could result in death or serious injury.

### CAUTION

This symbol indicates a hazardous situation, which, if not avoided, could result in minor or moderate injury.

### NOTICE

This symbol addresses practices not related to physical injury.

# IMPORTANT INSTRUCTIONS

## READ AND SAVE THESE INSTRUCTIONS

### CAUTION

1. This appliance is not intended for use by persons (including children) with reduced physical, sensory or mental capabilities, or lack of experience and knowledge, unless they have been given supervision or instruction concerning use of the appliance by a person responsible for their safety. Children should be supervised to ensure that they do not play with the appliance.
2. Never insert fingers, pencils, or any other object through the grille when the fan is running.
3. If the supply cord is damaged, it must be replaced by manufacturer or its service agent or a similarly qualified person in order to avoid a hazard.
4. Disconnect the fan when moving it from one location to another.
5. Be sure the fan is on a stable surface when operating to avoid overturning.
6. Do not use the fan by window. For rain may create electrical hazard.
7. When the fan was assembled, the rotor blade guard shall not be taken off anymore.
  - Unplug the fan for prior cleaning.
  - The rotor guard shall not be disassembled/opened to clean the rotor blades.
  - Wipe the fan enclosure and rotor blade guard with a slightly damp cloth.

# IMPORTANT INSTRUCTIONS (cont.)

## WARNING

1. If the supply cord is damaged, it must be replaced by manufacturer or its service agent or a similarly qualified person in order to avoid a hazard.
2. To protect against the risk of electrical shock, do not immerse the unit, cord or plug in water or other liquid.
3. When the appliance is not in use and before cleaning, unplug the appliance from the outlet.
4. This appliance has a polarized plug (one blade is wider than the other). To reduce the risk of electric shock, this plug is intended to fit in a polarized outlet only one way. If the plug does not fit fully in the outlet, reverse the plug. If it still does not fit, contact a qualified electrician. Do not attempt to defeat this safety feature.
5. **WARNING**—To reduce the risk of fire or electric shock, do not use this fan with any solid-state speed control device.
6. This product employs overload protection (fuse). A blown fuse indicates an overload or short-circuit situation. If the fuse blows, unplug the product from the outlet. Replace the fuse as per the user servicing instructions (follow product marking for proper fuse rating) and check the product. If the replacement fuse blows, a short-circuit may be present and the product should be discarded or returned to an authorized service facility for examination and/or repair.

# IMPORTANT INSTRUCTIONS (cont.)

## WARNING

a) “Do not operate any fan with a damaged cord or plug. Discard fan or return to an authorized service facility for examination and/or repair.”

b) “Do not run cord under carpeting. Do not cover cord with throw rugs, runners, or similar coverings. Do not route cord under furniture or appliances. Arrange cord away from traffic area and where it will not be tripped over.”

7. Do not leave the fan running unattended.

8. To Reduce The Risk Of Fire, Electric Shock Or Injury To Persons, Do Not Use Replacement Parts That Have Not Been Recommended By The Manufacturer (e.g. Parts Made At Home Using A 3D Printer).

9. Please note that any changes or modifications of this product not expressly approved by the party responsible for compliance could void the user's authority to operate the equipment.

## PART NAMES

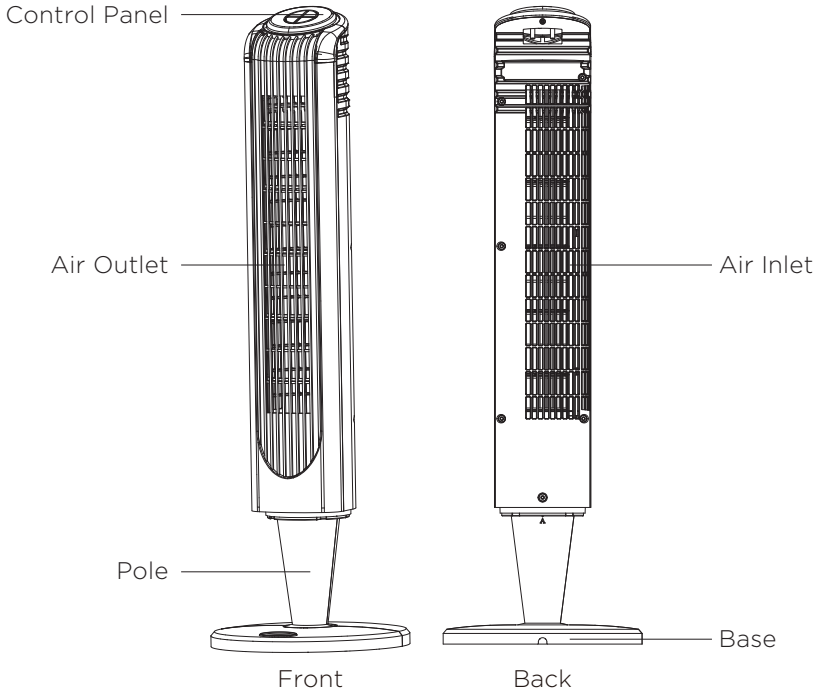

## NOTICE

All the pictures in this manual are for explanation purposes only. Any discrepancy between the real object and the illustration in the drawing shall be subject to the real model.

## SPECIFICATIONS

MODEL	Voltage	Frequency	Rated Current
PFZ36R0APK	120V-	60Hz	0.4A

## HOW TO ASSEMBLE



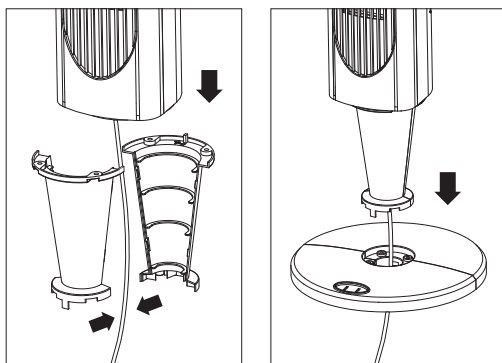

1. Pass the power cord through the channel in both parts of the pole, and securely connect the two parts to form a complete pole.
2. Align the larger end of the pole to the bottom of the fan body. Attach the fan body to the pole by tightening four M4×8 cross-head screws with a screwdriver.
3. Pass the power cord through the central gate and the slot at the bottom of the base. Firmly attach the rear base to the front base, ensuring the alignment of the pole with the front base, and secure it by tightening the four M4×12 cross-head screws with a screwdriver.

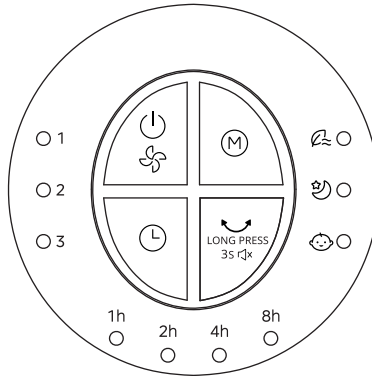

## OPERATING INSTRUCTIONS

1. Place the fan on a stable, even surface.
2. Plug the power cord into an appropriate power point and switch on power to the outlet.
3. To operate the fan, use the four push buttons on top of the fan, or the equivalent buttons on the remote control. Both sets of buttons allow you to switch the unit on or off, set the speed, set the switch-off time, and select the oscillation mode. The corresponding symbol will light up according to the mode selected.



Button	Function description
 <b>On/OFF &amp; Speed</b>	<ul style="list-style-type: none"> <li>• Press this button to switch the tower fan on (or off during operation). The unit must be switched on before you can adjust the timer, speed or oscillation mode.</li> <li>• Press this button to cycle through the three speed options: 1-low, 2-medium or 3-high.</li> </ul>
 <b>Wind Mode</b>	<ul style="list-style-type: none"> <li>• Press this button to cycle through the four wind mode selections: natural, sleep, baby or normal.</li> </ul>
 <b>Timer</b>	<ul style="list-style-type: none"> <li>• Press this button to navigate through the timer options. The fan will automatically turn off after the chosen time has passed. Press once to set the timer for one hour, and increase the time gradually by pressing it repeatedly. The timer can be set for up to 15 hours. All indicator lights illuminate indicating a 15-hour timer has been set.</li> </ul>
 <b>Oscillation</b>	<ul style="list-style-type: none"> <li>• Press this button to start or stop the fan oscillating.</li> <li>• Press and hold this button for 3 seconds to mute the device.</li> </ul>



## REMOTE CONTROL

- The remote control can be used normally within 16 feet in the front of the product and within an angle of 30°.
- The battery contains heavy metals, acid and alkali substances, which threaten human health; waste batteries should be sorted and recycled.

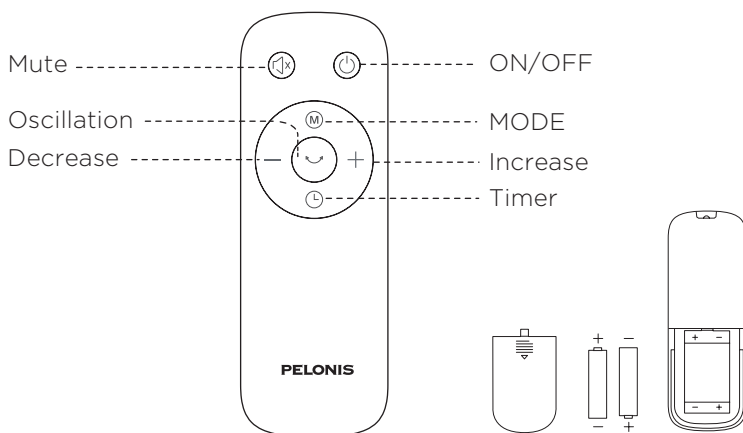

(AAA battery 1.5V)

Only use manganese or alkaline AAA batteries that are recyclable.

### **⚠ WARNING**

- Use standard or alkaline batteries of type "AAA". DO NOT use rechargeable batteries.
- Do not mix new batteries with old.
- Do not mix alkaline, standard (carbon-zinc) or rechargeable (ni-cad, ni-mh, etc.) batteries.

## CLEANING MAINTENANCE

- Be sure to unplug from the electrical supply source before cleaning.
- Please use a damp cloth or sponge for general cleaning.
- To remove persistent dirt, use a cloth dampened with warm soapy water and thoroughly wipe to remove soap film with a damp cloth. Do not use any solvents (such as thinners), as these may damage the plastic casing.
- Be sure not to make water or other liquid enter inside of the motor.

## TROUBLESHOOTING

If the product does not operate or does not operate properly, first check according to the following list. If the reason the product does not operate or does not operate properly is not included in the following list, the product may have failed. At this time, it is recommended to send the product to the dealer for repair.

Problem	Solution
The tower fan does not turn on	<ul style="list-style-type: none"><li>• Check whether the power outlet switch has been turned on.</li><li>• Check whether the plug is connected to the power outlet.</li></ul>
The remote control doesn't work	<ul style="list-style-type: none"><li>• Check the battery state of the remote control and, if required, replace batteries with new ones.</li><li>• Check that the remote control is being used within 16 feet of the unit.</li></ul>
Air flow is restricted	<ul style="list-style-type: none"><li>• Check whether the fan blades are dirty.</li><li>• Check whether the vents are clogged. You can remove any dirt and unclog vents with a dry cloth.</li></ul>
The buttons on the control panel or the remote control don't work	<ul style="list-style-type: none"><li>• Check whether the buttons are stuck.</li><li>• Clean the buttons with a damp cloth.</li></ul>
The tower cooling fan does not oscillate.	<ul style="list-style-type: none"><li>• Check that there are no obstructions to the unit. If you have any further issues, contact After Sales Support.</li></ul>

## USER SERVICING INSTRUCTIONS

- a) Grasp plug and remove from the receptacle or other outlet device. Do not unplug by pulling on cord.
- b) Open fuse cover. Slide open fuse access cover on top of attachment plug towards blades. (Fig. ①)
- c) Remove fuse carefully. Insert the tip of your tool into fuse slot (close with the terminal), then pry the fuse gradually and slowly, but do not overexert. If you feel resistance, you can try it at several times and pry the fuse little by little. When one side of the fuse has been released, then you can get the fuse out entirely. (Fig. ②)
- d) Risk of fire (fix spacing). Replace fuse only with 2.5 Amp, 125 Volt fuse. (Fig. ③)
- e) Close fuse cover. Slide closed the fuse access cover on top of attachment plug. (Fig. ④)
- f) Risk of fire (fix spacing). Do not replace attachment plug. Contains a safety device (fuse) that should not be removed. Discard product if the attachment plug is damaged.
- g) If the fan suddenly does not work during normal operation, please check whether it is a problem with the fuse.

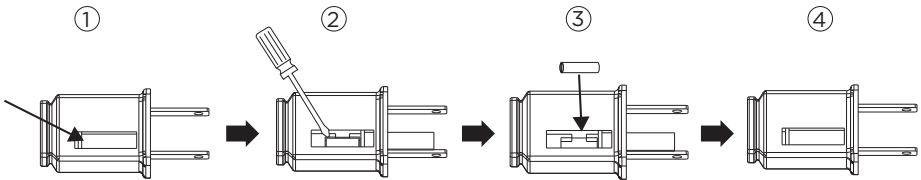

### NOTICE

- When you replace the fuse, please don't operate suddenly or overexert, or else the product will be damaged or cause accident.
- When you feel it hard to be operated, please make sure you have got the right way.
- Risk of fire. Do not replace attachment plug. Contains a safety device (fuse) that should not be removed. Discard product if the attachment plug is damaged.

# SERVICE AND SUPPORT

In the event of a warranty claim, questions, comments or if service is required for this product, please contact us at the following:

Toll Free: 1-866-646-4332

Email us at: [customerservice@supportuscenter.com](mailto:customerservice@supportuscenter.com)

Midea America Corp.

Parsippany, NJ 07054

For your records, staple your sales receipt to this manual and record the following:

**DATE OF PURCHASE:** \_\_\_\_\_

**PLACE OF PURCHASE:** \_\_\_\_\_

**(STAPLE SALES RECEIPT HERE)**

**NOTE: PROOF OF PURCHASE  
IS REQUIRED FOR ALL WARRANTY CLAIMS  
PRINTED IN CHINA**

# ONE (1) YEAR LIMITED WARRANTY

- Please read all instructions before attempting to use this product.

Midea America Corporation warrants as limited herein to the original purchaser of retail thateach new Fan, shall be free of defects in material and workmanship for aperiod of one (1) year from the date of original purchase. This one (1) year warranty is limited to the Motor and Electric Element.

In the event of malfunctions or failure of your Fan, simply deliver or send the Fan, postage prepaid along with PROOF OF PURCHASE, within the warranty period of one (1) year, to Midea America Corporation. Midea America Corporation reserves the right to inspect the claimed defective part or parts to determine if the defect or malfunction complaint is covered by this warranty. Midea America Corporation shall, within sixty(60)days after receipt of the product, at its option, repair and/or replace the defective part or parts free of charge. This warranty shall only cover defect arising from normal usage. Midea America Corporation assumes no responsibility whatsoever if the Fan should fail during the warranty period by reason of:

- Misuse, negligence, physical damage or accidents.
- Lack of maintenance (see instructions for proper maintenance).
- Repair by any unauthorized party during the warranty period.
- Damage caused by connection to an improper input voltage (see specification label on your Fan).

Midea America Corporation makes no further warranties or representations, express or implied except those contained herein. No representative or dealer is authorized to assume any other liability regarding the Fan. The duration of the implied warranty granted under State law, including warranties of merchantability and fitness for particular purpose are limited in duration should the duration of the express warranty grant it hereunder. Midea America Corporation shall in no event be liable for direct, indirect, special or consequential damages.

Some states do not allow limitations on how long an implied warranty lasts, and/or the above limitations or exclusion may not apply to you. This warranty gives you specific legal rights and you may have other rights which vary from state to state.







**PELONIS™**